

EN

GEM-OX-L installation guide

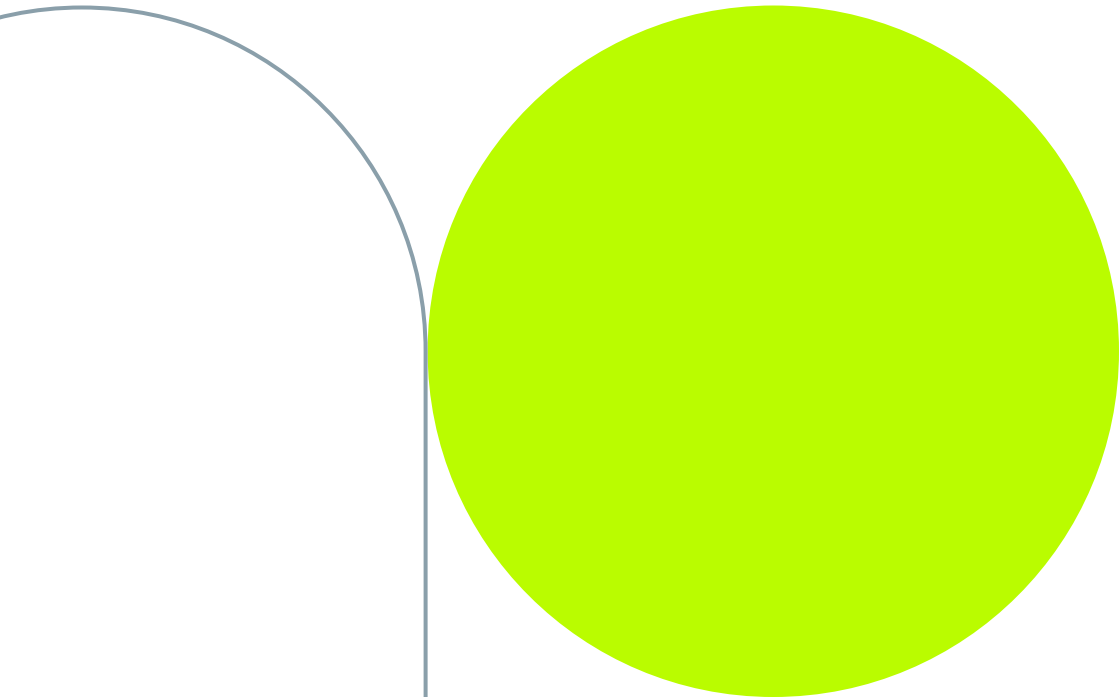

GemOne[®]



Content

General information	4
Technical specs	5
Dimensions	6
Wiring	7
Wiring guidelines	8
B+	8
ACC (Digital input 1)	8
Digital input 2	9
Digital input 3	9
Schematic	10
Antennas	11
LEDs	12
Navigation LED	12
Status LED	13
Deep sleep mode	14
Input filtering	15
FAQ / Troubleshooting	16
Support	18

General information

The GemOne tracker is a very smart tracker, which combines basic tracking (location and usage based on its inputs) with advanced functionalities (enabling geofences and impact detection, accelerometer...).

The tracker is IP67, which means that it can handle a lot of dust and water. It even withstands being thrown into water with a depth of less than 1 meter. This means its installation should not be protected from dust, rain or splashes of water. See the installation instructions for more information.



Technical specs

Power

Working voltage: 6 - 30V DC with over voltage protection
Battery: 400 mAh Ni-MH internal backup battery

Physical specifications

Dimensions: 2.85 × 2.87 × 1.07 inches
Weight: 7,23 ounces
Ingress protection: IP67
Operating temp.: -40°F to 185°F
Conformity & Certifications: CE/RED, E-Mark, EAC, RoHS, REACH

GSM (data)

Internal high gain antenna
2G Quad-band 850 / 900
1800 / 1900 MHz
SMS / TCP / UDP
Internal 128MB flash memory
for data

GNSS (positioning):

Receiver: GPS, GLONASS,
GALILEO, BEIDOU,
SBAS, QZSS,
DGPS, AGPS
Antenna: Internal high
gain antenna
Accuracy: < 9.84 ft

Connectivity

Bluetooth 4.0 + LE
2 status LEDs
3 digital inputs
2 digital outputs
1 analog input
1-wire interface + power

Supported peripherals





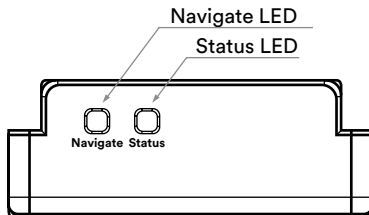
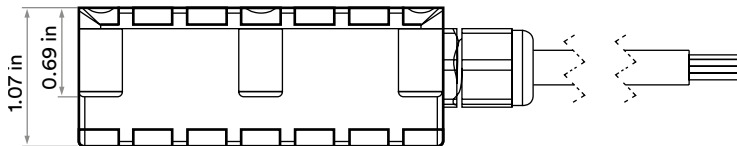
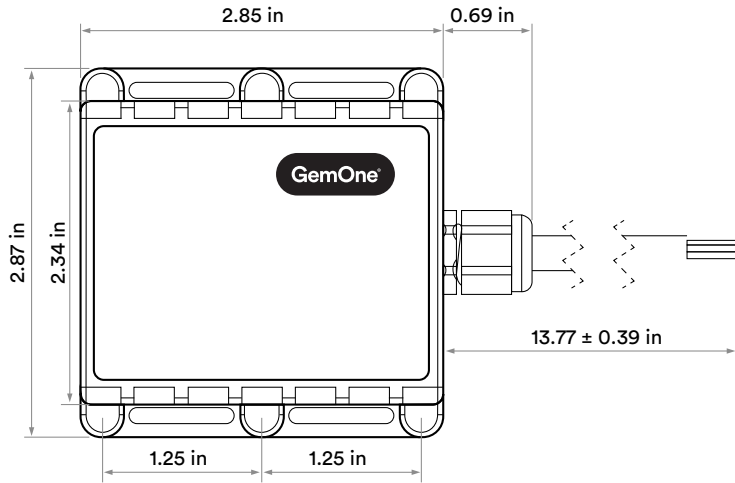





Built-in accelerometer
Temperature and humidity sensors
Universal BLE sensor support
RFID reader

Dimensions



Wiring

Be careful, this tracker can only have 30V as input voltage! Use a DC-DC converter for machines with higher battery voltage.

Nr	Wire color		Connection	Description
1	Red		B+	Attach to permanent 6-30V DC supply via a 1A fuse (mandatory)
2	Black		Ground (GND)	Attach to the ground or '-' pole of your machine or battery (mandatory)
3	Yellow		DIN1 (Ignition)	Digital input 1: Ignition input (mandatory) - 0 up to 30V tolerance - Din1 0-7.5V is logic '0', Ignition off - Din1 8-30V is logic '1', Ignition on
4	White / green		DIN2	Digital input 2: Hour counter - 0 up to 30V tolerance - Din2 0-2.5V is logic '0', Ignition off - Din2 3-30V is logic '1', Ignition on
5	White		DIN3	Digital input 3: Optional - 0 up to 30V tolerance - Din3 0-2.5V is logic '0', Ignition off - Din3 3-30V is logic '1', Ignition on
6	Grey		AIN1	Analog input 1 - 0V to 30V
7	White / orange		DOUT1	Digital output 1: Access control Open-drain with I _{max} = 500mA
8	Purple		DOUT2 (Relay)	Digital output 2: Access control relay output Open-drain with I _{max} = 500mA
9	Green		1 WIRE DATA	Access control data
10	Blue		1 WIRE POWER	Do not connect - Reserved for future use

Wiring guidelines

- **B+**

The tracker must always be powered, preferably directly to the battery of your machine. It must be connected before the emergency switch and key switch to ensure a continuous power supply.

If the tracker is not powered continuously, location of your machine, access control and other features may not work as expected.

- **Digital input 1**

Digital input 1 represents the ignition input of our tracker. It is mandatory to connect it to the ignition of your machine. The tracker depends on this input to regulate sleep mode, access control and other advanced features.

The signal must be:

- Low when the machine is off (<8V)
- High when the machine is switched on (>8V) - before the engine is running
- High while the engine is running
- Low when the machine is turned off

- **Digital input 2**

Digital input 2 represents the hour counter, but - unlike digital input 1 - it is not mandatory to connect it to your machine.

You are free to connect it to any point in your machine which monitors the usage:

- Physical hour counter with on/off input
- Signal indicating when the engine is on/off
- Pneumatic or hydraulic pumps on/off
- Seat switch
- Foot pedal

If none of the above suggestions are available on your machine, you can opt to base the hours calculation on the ignition input in our cloud platform.

- **Digital input 3**

Digital input 3 is optional and can be used to capture additional information from your machine.

Some machines place the main breaker or the emergency switch between the '-' pole of the battery and the chassis. This will cause invalid signals on all inputs. To prevent this from happening, digital input 3 can be wired to the chassis. More information can be found in section [Input filtering](#).

Schematic

You can find the wiring scheme of the basic installation below. With this installation, the ignition and hour meter will be captured. Digital input 3 can be used to capture additional information from your machine.

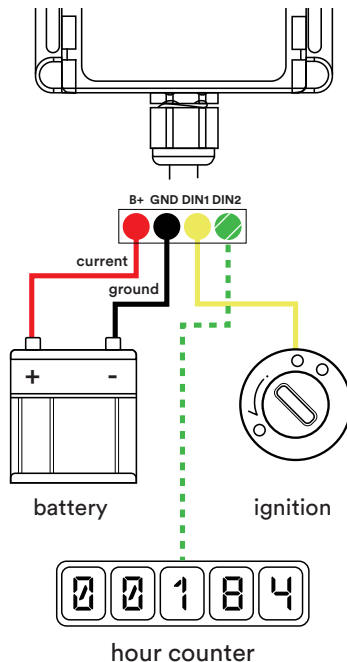

B+, GND and DIN1 are mandatory for every installation.

Access Control

Our GemOne trackers can be equipped with access control accessories to add driver identification and access control to your existing fleet. For more information and guidelines on the installation, we refer to our GEM-ACC-KP installation guide.

Antennas

The GemOne tracker has an internal GNSS (GPS) and GSM antenna.

For the antennas to work correctly, the tracker should be mounted with the sticker view to the open sky (metal free) with not less than $\frac{3}{4}$ of metal free area as shown in figure below.

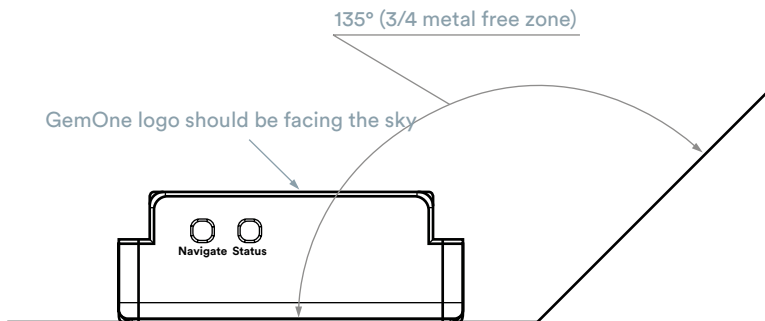

It is not important in which direction the tracker is installed. The most important instruction is that the GSM and GNSS antenna have a good open view.

LEDs

The tracker has two LEDs: a navigation LED and a status LED. Both LEDs have a green color.

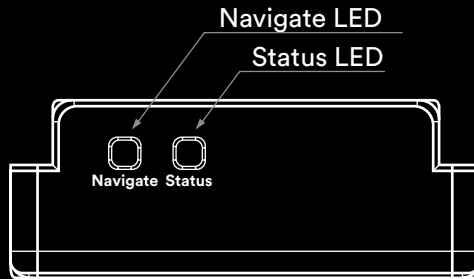

Navigate LED

Behaviour	Meaning	OK?
Permanently switched on	GPS signal is not received	No
Blinking every second	Normal mode, GPS is working	Yes
Off	GPS is turned off because: Deep sleep mode Or GPS antenna short circuited	Yes No

If the Navigate LED is off, check the status LED (see next page) to make a distinction between Deep sleep mode and GPS antenna short circuited. The latter won't happen often.

Status LED

Behaviour	Meaning	OK?
Blinking every second	Normal mode	Yes
Blinking every 2 seconds	Deep sleep mode	Yes
Blinking fast for a short time	Modem activity	Yes
Blinking fast constantly	Boot mode	Yes

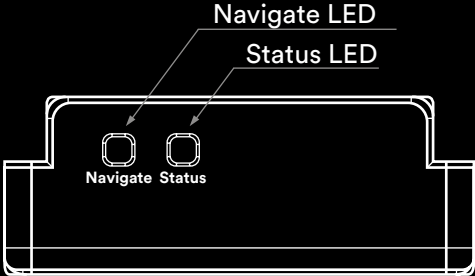

Deep sleep mode

The tracker is configured to use Online Deep Sleep mode. If no movement is detected and the ignition is off (input 1), after 10 minutes it will go into Sleep mode. This means that the GPS module is switched off. The tracker still works normally. It sends data when something changes on its inputs. It also sends a message every hour if no activity is detected.

If the tracker is in Online Deep Sleep, we can still reach it via SMS (to wake up e.g.).

Sleep mode is switched off when the internal accelerometer detects a movement or when the ignition is switched on.

Input filtering

Some machines put the main breaker between the '-' pole of the battery and the chassis (ground wire). In that case, the machine is always connected to the '+' pole of the battery. This could cause a voltage on the inputs of our telematics module, which will be interpreted as activity (eg. ignition on, hour counter running, ...)

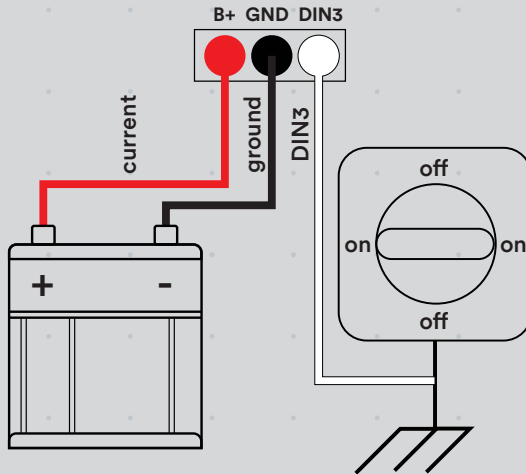

To detect this situation, the tracker needs an additional connection (DIN3 - white) to the chassis. This input can detect invalid signals and will allow the cloud platform to filter other invalid inputs as well. Make sure you enable input filtering in the cloud platform on digital input 3 when this feature is needed.

FAQ / Troubleshooting

- **None of the LEDs turn on.**
 - Verify if the tracker has power between B+ (yellow) and GND (black). The tracker needs a voltage between 9-90V
 - Verify if the 1A fuse is still intact
 - Make sure that the ignition input (ACC) is wired correctly

- **The tracker sends data but I can't see the location of the vehicle.**

Verify if the installation was done according to the guidelines. The GemOne logo should face the open sky, without metal obstructions. See 'Antennas' section for more information.

The GPS signal isn't always available inside so location tracking may not work indoors.

- **Ignition or hour counter input stays high - even if the machine is not running.**

Check if the ignition is actually used by the operators. In a lot of cases, the emergency switch is used instead of the ignition switch. On some machines, this disables the machine but keeps the ignition signal high. The installation must match the actual usage of the machine. If the emergency switch is used instead of the ignition switch, then it might be better to use another point in the machine. Please consult your machine's technical documentation for more information.

The same applies to all other inputs including digital input 2 (hour counter).

- **My machine has multiple control panels - which ignition signal do I use?**

Some machines have multiple control panels, each with its own key switch and/or emergency stops (eg. one on the platform and another on the ground control panel). In that case, you have to make sure that the ignition digital input of our tracker measures both signals. Some machines have a combined signal available, please consult your schematic and manual.

If no combined signal is available in the machine, one can be constructed using two diodes:

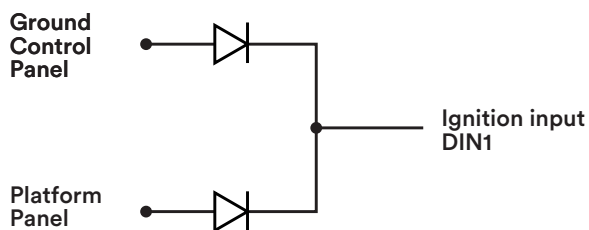

Make sure you use suitable diodes for your application (maximum voltage, ...). Commonly used diode types are: 1N4005 or 1N4007

Support

In case of issues, questions or feedback, feel free to contact our support team.

 +1-844-275-2801

 techservice@gemone.com

Save time with our connectors

Request connectors for your machines to save time while installing this tracker. GemOne offers a multitude of different connectors. Get in contact with your account manager for an offer.



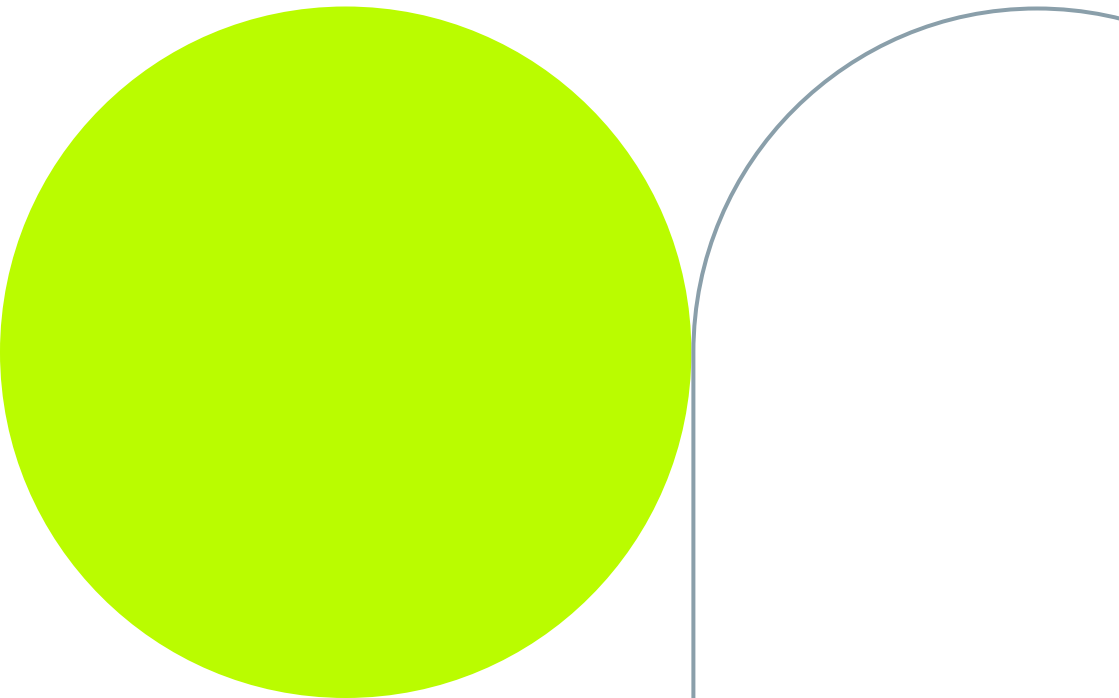

Lets get connected:

- 📷 [instagram.com/gemoneofficial](https://www.instagram.com/gemoneofficial)
- 📘 [facebook.com/gemone.telematics](https://www.facebook.com/gemone.telematics)
- 🌐 [linkedin.com/company/gemone](https://www.linkedin.com/company/gemone)
- 🐦 twitter.com/GemOne_
- ✉️ support_emea@gemone.com

www.gemone.com



©2021 - GemOne NV, Spinnerijstraat 99/23, BE-8500 KORTRIJK. All rights reserved. No part of this publication may be reproduced or communicated in any form or by any means, electronic or mechanical, including copying, recording or use in an information storage or retrieval system, without prior and explicit permission of GemOne NV. Photographs and illustrations are included for reference purposes only. GemOne is a registered brand.