

GemOne®

Machine Connectors

Plug & play. It's that simple.



Save technicians time:

No more long, complicated installations.



Avoid installation errors:

No more loose wires or faulty signals.



Uniform installation:

No more frustrating variation across your fleet.

Why connectors?



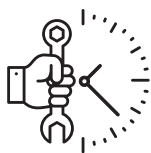

Make better use of your technicians' valuable time.

When using existing manufacturers' connectors on your machines, you'll **reduce tracker installation time from 2 hours to just 30 minutes.**

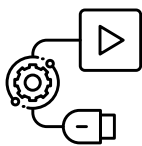

Start using your trackers immediately, without technical problems.

Once connectors have been wired into your machines, you'll **fully eradicate tracker installation errors.**

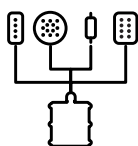

Install trackers on every type of machine in your fleet — in the same, easy way.

Once wired in, you'll ensure your **fleet has uniformity** in how trackers are installed.

How it works

We can configure the connectors on our trackers in different ways to suit the needs of your specific fleet.



1. Existing machine connections

Our tracker connectors are already compatible with connectors installed by most manufacturers on your machines. In this case, it's simple: **just plug directly into the OEM telematics connection** and begin tracking your machines immediately.

Even if the existing machine connectors are already in use, we have **model-specific adapters** for your fleet. Once these adapters are installed, you can easily and quickly plug-in our trackers to your machines.



2. Custom configuration

Where there are no existing machine connectors available on your machines, we have the expertise to **custom configure your machines with GemOne cables** to ensure standardised installation across your fleet.

Connect any machine

Our connectors are suitable for any industrial machine, meaning you can easily install our trackers on your entire fleet: forklifts, scissor lifts, boom lifts, and many more...



We can also provide specific connectors for different models of all machine brands.

Whatever type of machines you use, we've got connectors.



Install once Plug & play forever

If connectors don't already exist on your machine, you only need to install them once.

Whether it's existing connections, adapters, or custom configuration, we've got connectors that make installation of trackers on your fleet quick, easy, and error-free.



Need to swap a tracker thereafter?



Just plug it out and plug in a new one.

All the information you need

Digital Input/Output

Connect trackers that provide you with **all the information you need** to boost fleet efficiency, reduce maintenance costs, increase company revenue, and optimise your business.

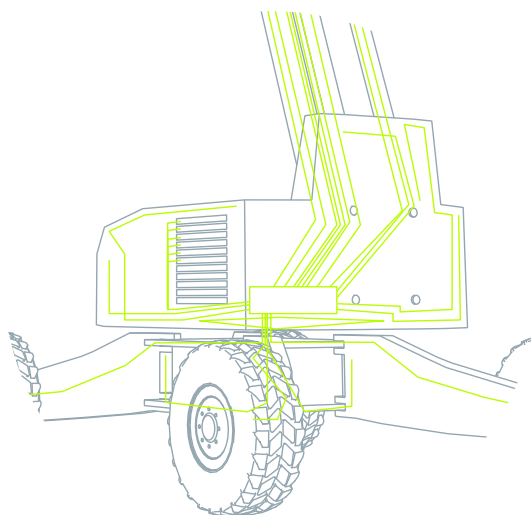

CAN data

Use connectors to plug your tracker into **the machine's CAN bus**. CAN data provides you with the exact values of machine usage as well as other important technical data, depending on the machine type, such as error codes, engine RPM, and temperatures.

Access Control

Connectors also make it possible to **connect your tracker to access control systems** for access control functionality and data.









GemOne®

Easily connect
trackers to your
machines so you
can **save** your
technicians time,
avoid connection
errors, and enjoy
uniform installation
across your fleet.



Contact us:

Contact us to discuss
the right connectors
for your fleet.

-  GemOne
Spinnerijstraat 99/23
8500 Kortrijk
Belgium
-  info@gemone.com
-  [instagram.com/gemoneofficial](https://www.instagram.com/gemoneofficial)
-  [facebook.com/gemone.telematics](https://www.facebook.com/gemone.telematics)
-  [linkedin.com/company/gemone](https://www.linkedin.com/company/gemone)
-  twitter.com/GemOne_

© 2023 - TVH Parts Holding nv, Brabantstraat 15, B-8790 Waregem. All rights reserved. No part of this publication may be reproduced or communicated in any form or by any means, electronic or mechanical, including copying, recording or use in an information storage or retrieval system, without prior and explicit permission of TVH Parts Holding nv. Photographs and illustrations are included for reference purposes only. GEM One is a brand of TVH Parts Holding nv.

www.gemone.com