

EN

# GemOne Onyx V4 installation guide



**GemOne®**

A company of **TVH**

**The first pages  
of this installation guide  
contain the Quick Install  
steps covering:**

- *Basics***
- *Access Control***

# Quick Install

## - *Basics*

- **Collect the necessary information to register on the online platform**
  - Tracking device IMEI number
  - Machine make
  - Machine model
  - Machine serial number
  - Machine manufacturing year
- **Locate where to connect the permanent power supply (9 - 97Vdc)**
- Locate where to connect the inputs  
In1 Key reflects the key switch signal.  
This is the only mandatory input.  
All inputs are by default active when voltage is 4.5V - 97VDC, measured from a **common ground**.
- **Find the place to mount the tracking device:**  
optimal GPS signal = status LEDs facing upwards to sky, device is not enclosed in a metal box.  
Make sure the internal GPS antenna has a clear view of the sky and is not covered by any metal parts.  
An ideal position is under the dashboard plastic cover.
- **Unwrap the tape** from the harness for as long as needed to connect the necessary wires. Try to keep wires as short as possible by cutting the wiring harness to the minimum length.
- **Insulate unused wires** with electrical tape to prevent unwanted contact or short circuits in the machine.

- **Remove power from the machine before installation** to prevent dangerous situations and damage to your machine or tracker.
- **Connect the wires** using a soldering iron and shrinking tube. Alternatively, you can use spades, O-rings or other connectors.

If the harness has a connector to connect with the machine: connect the plug and play connector.  
No wiring is needed in this case

- **Mount the tracking device** using heavy duty double sided tape on a degreased surface. Alternatively, you can use the 3 mounting tabs to attach the device with M6 bolts or zip ties.
- **Connect the tracking device to the harness**
- **Reconnect the battery; test the installation**



**If access control is applicable - refer to the next page**

# Quick install

## - Access Control

- **Locate which wires to interrupt** to block the machine from being used. Typical wires to cut are:
  - Coil of starter relay
  - Seat switch
  - Seat belt switch
  - Dead man switch
  - ...
- **Connect the wires:**  
Put the 2 white relay wires (Relay NO and Relay COM) where the interruption was made.



- **Install the keypad in a place easily reachable for the operator (eg. on the dashboard). Make sure not to obstruct the operator view or interfere with other controls in the machine.**
- **Connect keypad to the wiring harness; reconnect the machine power and test the installation**
- **Make sure access control is activated by having the correct configuration on the platform**

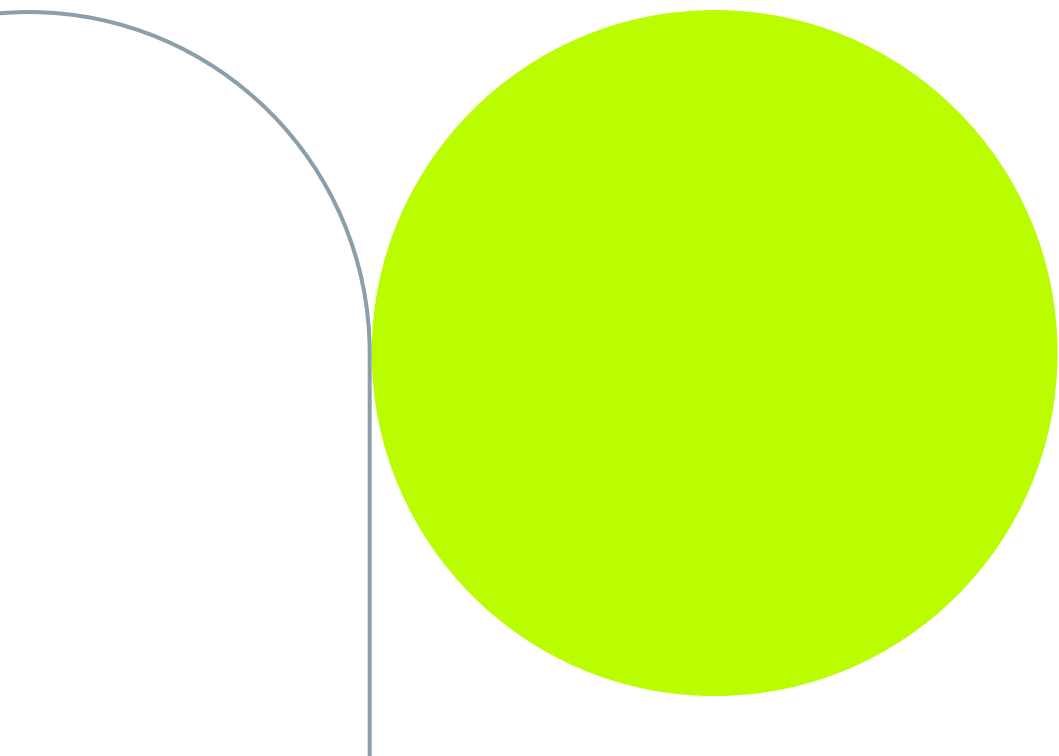

# Content

<b>General information</b>	<b>8</b>
<b>Technical specs</b>	<b>9</b>
<b>Dimensions</b>	<b>10</b>
<b>Wiring</b>	<b>11</b>
Connector and pinout	11
Pinout description	12
Default wiring harness	14
Custom wiring harness and connectors	15
Wiring schematics	16
Wiring guidelines	17
<b>Mounting positions</b>	<b>19</b>
Antennas	19
Mounting	20
<b>LEDs</b>	<b>21</b>
Data	21
Power	21
GPS	21
<b>Sleep mode</b>	<b>22</b>
<b>Access control</b>	<b>23</b>
General information	23
Technical specs	23
Dimensions	24
Wiring and pinout	24
Wiring schematics	25
Which signal to interrupt?	27
Telematics connector	30
How to use	31
<b>Post installation verification</b>	<b>32</b>
QR-code on the Onyx V4 device	32
Consulting the installation verification page	33
Keeping machine data secured	33
<b>FAQ / Troubleshooting</b>	<b>34</b>
<b>Support</b>	<b>38</b>

# General information

The Onyx V4 is a smart telematics unit, which combines basic tracking (location and usage based on its inputs) with advanced functionalities (enabling geofences and impact detection, accelerometer...).

With 4G connectivity, high-voltage compatibility, built-in relay, and Dual-CAN support, the Onyx V4 seamlessly meets all your industrial fleet tracking needs.

The Onyx V4 is IP67, which means it can withstand dust and water. Installations should not be protected from dust, rain or splashes of water.

See the installation instructions for more information.





# Technical specs

## Power

**Working voltage:** 9 - 97V DC with over voltage protection up to 120V  
**Battery:** 2550 mAh Li-ion internal backup battery

## Physical specifications

**Dimensions:** 166(L) x 90(W) x 40(H) mm  
**Weight:** 336g  
**Ingress protection:** IP67  
**Operating temp.:** -20°C - 60°C  
**Conformity & certifications:** CE/RED, FCC, PTCRB, RoHS, UL/ULC & EE

## GSM (data)

3FF SIM slot + eSIM  
Internal antenna  
4G LTE Cat 1 with 2G fallback:  
LTE-FDD: B1 / 2 / 3 / 4 / 5 / 7 /  
8 / 12 / 13 / 17 / 18 / 19 / 20 /  
25 / 26 / 28 / 66  
LTE-TDD: B34 / 38 / 39 / 40 / 41  
GSM: B2 / 3 / 5 / 8

## GNSS (positioning)

**Receiver:** GPS, GLONASS, BDS,  
Galileo & QZSS  
**Accuracy:** 2.5 meters

## Supported peripherals

Built-in impact and movement  
detection: 3 axis accelerometer -  
3 axis gyroscope  
Keypad / RFID reader

## Connectivity

Bluetooth 5.4 & LE  
3 status LEDs (Data, Power and GPS)  
2 CAN-FD busses: Automatic baudrate detection  
Multiprotocol support: (J1939/CANOpen/Custom)  
Configurable bus termination - 8 analog / digital inputs (0-97V)  
2 digital outputs (built-in relays) - 12V / 2A output power  
Wiegand interface - RS485 with configurable bus termination

# Dimensions

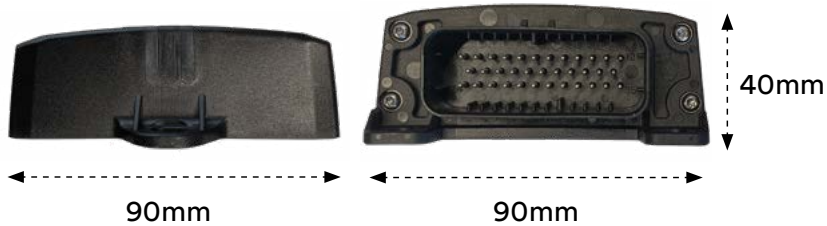

# Wiring

## Connector and pinout

The Onyx V4 uses a 35-pin connector which mates with TE 776164-1 and has the following pinout:

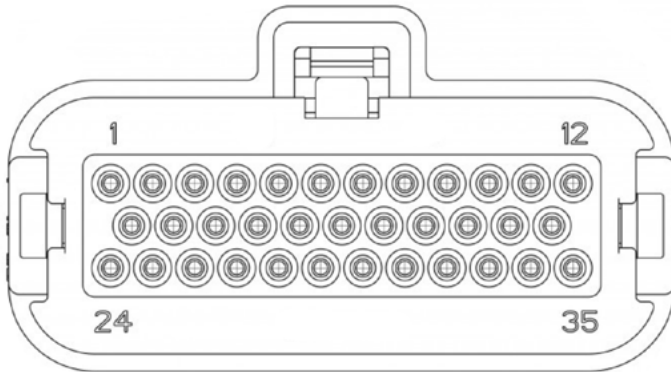

- |                           |                             |
|---------------------------|-----------------------------|
| 1. Bat +                  | 19. Relay 2 - Normal open   |
| 2. GND                    | 20. Relay 2 - Normal closed |
| 3. 12V +                  | 21. CAN1 - Low              |
| 4. 12V -                  | 22. CAN1 - High             |
| 5. N/A                    | 23. CAN2 - Low              |
| 6. Ain1 / In1 Key         | 24. CAN2 - High             |
| 7. Ain2 / Din2            | 25. RS485 - A               |
| 8. Ain3 / Din3            | 26. RS485 - B               |
| 9. Ain4 / Din4            | 27. N/A                     |
| 10. Ain5 / Din5           | 28. N/A                     |
| 11. Ain6 / Din6           | 29. RFID keypad D0          |
| 12. Ain7 / Din7           | 30. RFID keypad D1          |
| 13. Ain8 / Din8           | 31. RFID Keypad LED         |
| 14. Relay 1 - Common      | 32. RFID Keypad Buzzer      |
| 15. Relay 1 - Normal open | 33. N/A                     |
| 16. N/A                   | 34. N/A                     |
| 17. N/A                   | 35. N/A                     |
| 18. Relay 2 - Common      |                             |

## Pinout description

The Onyx V4 has 3 mandatory pins which need to be connected to function properly:

- **Bat +** and **GND** providing constant power to the device
- **Ain1/In1 Key** indicating to the tracker when the machine is switched on

All other connections are optional and depend on your usecase.

Pin	Name	Standard harness colour	Description
1	Bat +	Red	Attach to permanent 10 - 97V DC supply via a 1A fuse (mandatory)
2	GND	Black	Attach to the ground or '-' pole of your machine or battery (mandatory)
3	12V +	-	12V + output with I <sub>max</sub> = 2A. This output is used to power external optional accessories (eg. RFID keypad)
4	12V -	-	12V output ground
5	N/A		Do not connect - Reserved for future use
6	Input 1 (key)	Yellow	Digital input 1: Ignition input (mandatory) - Din1 0 - 4.5V is logic '0', Ignition off (default threshold, configurable) - Din1 4.5 - 97V is logic '1', Ignition on Can be used to measure an analog voltage
7	Input 2	Grey	Digital input 2-7 with input range from 0 - 97V.
8	Input 3	Brown	
9	Input 4	Orange	Configurable threshold with default 4.5V: - 0 - 4.5V is logic '0' - 4.5 - 97V is logic '1'
10	Input 5	-	
11	Input 6	-	
12	Input 7	-	Can be used to measure an analog voltage
13	Input 8	-	Digital input 2-7 with input range from 0-97V. Configurable threshold with default 9V: - 0 - 9V is logic '0' - 9 - 97V is logic '1'

Pin	Name	Standard harness colour	Description
14	Relay 1 - COM	White	Built-in access control relay, used to block the machine. Normally open contact. Maximum 2A at 30V DC
15	Relay 1 - NO	White	
16-17	N/A	-	Do not connect - Reserved for future use
18	Relay 2 - COM	-	Built-in access control relay, used to block the machine. Normally open and normally closed contact with a maximum of 2A at 30V DC
19	Relay 2 - NO	-	
20	Relay 2 - NC	-	
21	CAN 1 - Low	White/ Green	Primary CAN bus, configurable internal 120 Ohm termination Connection depends on your machine type (eg. machine, engine, ...)
22	CAN 1 - High	White/ Yellow	
23	CAN 2 - Low	Grey/ Green	Secondary CAN bus, configurable internal 120 Ohm termination Connection depends on your machine type (eg. machine, BMS, ...)
24	CAN 2 - High	Grey/ Yellow	
25	RS485 - A	-	RS485 interface, used to connect to a controller (eg. generator) Configurable internal 120 Ohm termination
26	RS485 - B	-	
27-28	N/A	-	Do not connect - Reserved for future use
29	RFID keypad D0	-	Wiegand data lines (D0 and D1) used to receive the RFID card number or entered PIN code from the reader
30	RFID keypad D1	-	
31	RFID keypad LED	-	Signal from the Onyx v4 to the LED indication on the RFID keypad
32	RFID keypad buzzer	-	Signal from the Onyx v4 to the Buzzer in the RFID keypad
33-35	N/A	-	Do not connect - Reserved for future use

## Default wiring harness

By default, the Onyx V4 is delivered with the basic wiring harness, which provides the most common connections to your machine.

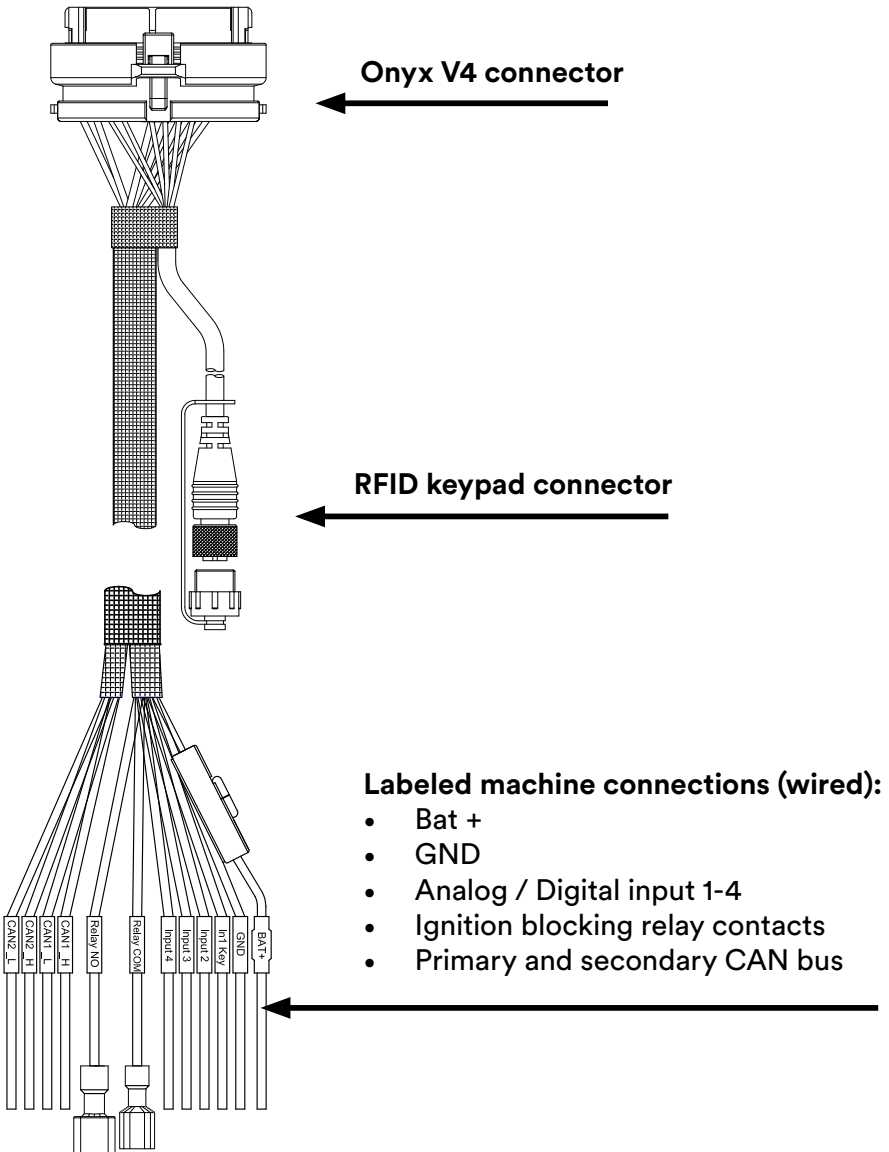

## Custom wiring harness and connectors

We can configure the connectors on our trackers in different ways to suit the needs of your specific fleet.

### **1. Generic wiring harness**

Our tracker connectors are already compatible with connectors installed by most manufacturers on your machines. In this case, it's simple: just plug directly into the OEM telematics connection and begin tracking your machines immediately.



Even if the existing machine connectors are already in use, we have model-specific adapters for your fleet. Once these adapters are installed, you can easily and quickly plug-in our trackers to your machines.

### **2. Custom harness**

Where there are no existing machine connectors available on your machines, we have the expertise to custom configure your machines with GemOne cables to ensure standardised installation across your fleet.

Request for connectors for your machines to save time while installing this tracker. GemOne offers a multitude of different connectors. Get in contact with your account manager for an offer.



## Wiring schematics

Connect BAT+ and GND to a constant power supply of 12 - 80V (nominal), 7 - 97V (maximum). Make sure the power to the tracker is permanent and doesn't switch off when the machine is turned off. Always consult the manufacturer manual of your specific machine.

Connect digital input 1 to the keyswitch, this is a mandatory signal.

Other inputs can be connected but are optional (eg. digital input 2 as hour counter)

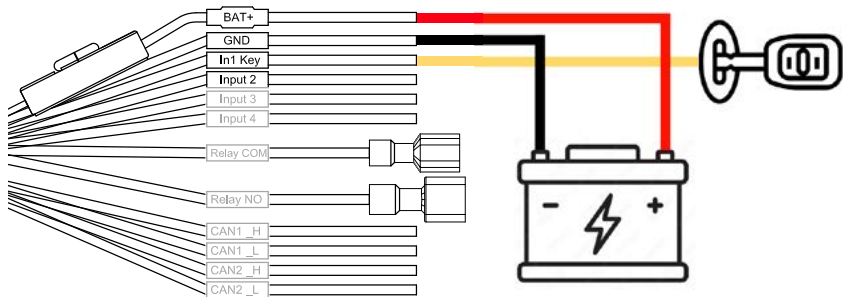

Connect the primary and secondary CAN bus to your machine, engine or BMS system. This allows the telematics unit to read out values directly from the ECU, VCU or BMS system. Always consult the installation instructions provided by GemOne for your specific machine. When in doubt, contact our support team.

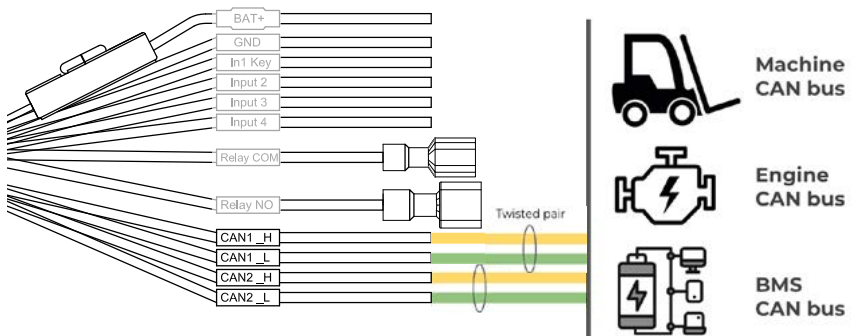



## Wiring guidelines

### ● **Bat+ and GND**

The tracker must always be powered, preferably directly to the battery of your machine. It must be connected before the emergency switch and key switch to ensure a continuous power supply. If the tracker is not powered continuously, location of your machine, access control and other features may not work as expected

### ● **Digital input 1**

Digital input 1 represents the ignition input of our tracker. It is mandatory to connect it to the ignition of your machine. The tracker depends on this input to regulate sleep mode, access control and other advanced features.

The signal must be:

- Low when the machine is off (0 - 4.5V)
- High when the machine is switched on - before the engine is running (4.5 - 97V)
- High while the engine is running
- Low when the machine is turned off

### ● **Digital input 2-8**

Digital input 2 represents the hour counter, but - unlike digital input 1 - it is not mandatory to connect it to your machine, especially when the exact hours can be read directly from the machine via CAN. You are free to connect DIN2 to any point in your machine which monitors the usage:

- Physical hour counter with on/off input
- Signal indicating when the engine is on/off
- Pneumatic or hydraulic pumps on/off
- Seat switch
- Foot pedal

If none of the above suggestions are available on your machine, you can opt to base the hours calculation on the ignition input in our cloud platform. Digital input 2 to 8 are optional and can be used to capture additional information from your machine.

- **CAN 1 and CAN2**

Connect the primary and secondary CAN bus to your machine, engine or BMS system. This allows the telematics unit to read out values directly from the ECU, VCU or BMS system. Always consult the installation instructions provided by GemOne for your specific machine. When in doubt, contact our support team.

# Mounting position

## Antennas

The Onyx V4 telematics unit has an internal GNSS and 2G/4G antenna.

For the antennas to work correctly, the tracker should be mounted with the sticker view to the open sky (metal free) with not less than  $\frac{3}{4}$  of metal free area as shown in figure below.

The GNSS antenna is located in the top left corner of the tracker. Specifically make sure not to cover this area in order to have reliable location tracking. Use the 3 mounting tabs to screw the device tightly to the chassis of the machine. M6 Allen keys are recommended.

### **GNSS antenna**

Keep clear of metal and point to sky

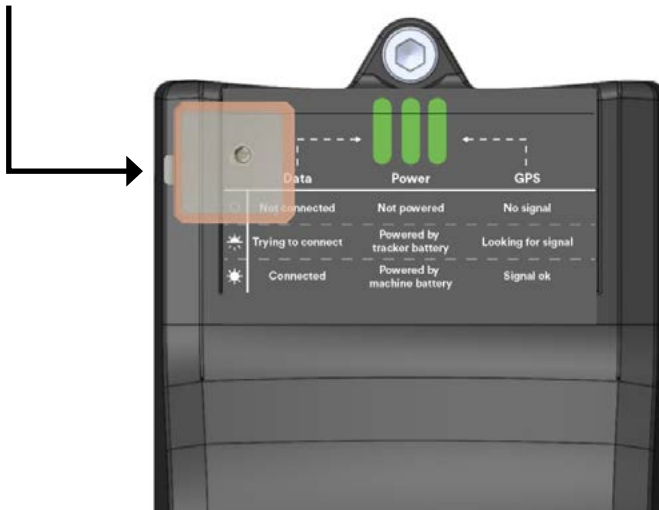

## Mounting

Mount the device in a reachable place, with the label visible and the antennas pointing to the sky (see Antennas section).

For the best movement and impact detection results, always mount the device to a fixed and sturdy part of the machine (eg. chassis). Make sure the device is properly attached and isn't moving around.

- **Double sided tape**

The flat surface of the tracker on the back allows you to mount the device in your vehicle using double sided tape.

- **Mounting tabs**

Use the 3 mounting tabs to screw the device tightly to the chassis of the machine. M6 Allen keys are recommended.

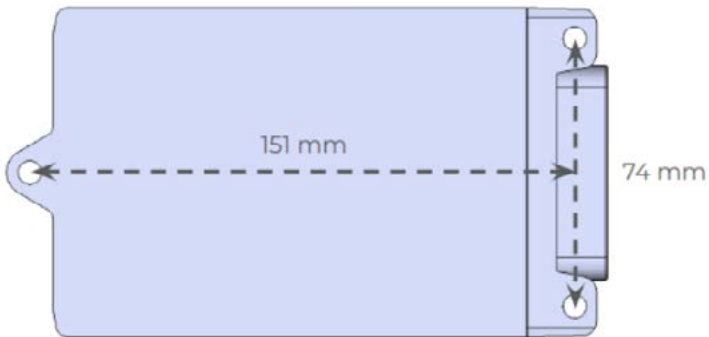

# LEDs

The device has 3 LEDs:

- **Data** - Showing the status of the mobile 2G/4G connection
- **Power** - Showing the status of the power supply
- **GPS** - Showing the location status (GNSS)

The print on the enclosure already provides a short summary what each LED indicates:

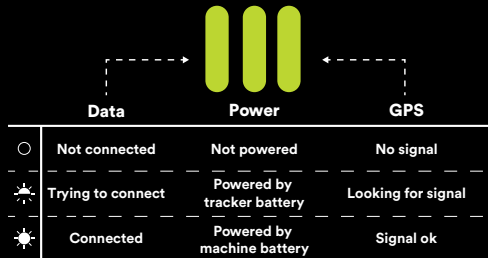

## Data

- **OFF** - The device has no active 2G/4G uplink (eg. no coverage or in sleep mode)
- **BLINKING** - The device is trying to establish a connection with the mobile network
- **ON** - The device is connected to the mobile network and able to send telemetry data

## Power

- **OFF** - The device has no external power and the internal battery is empty
- **BLINKING** - The device has no external power but is still running from the internal battery
- **ON** - The device has external power from the vehicle (9-97V)

## GPS

- **OFF** - The device has no location lock (eg. no signal or sleep mode)
- **BLINKING** - The device has no lock but is looking for satellites to get the location
- **ON** - The device knows its location and has a proper lock

# Sleep mode

The tracker is configured to go into sleep mode to preserve the vehicle's battery charge.

If no movement is detected and the ignition is off (digital input 1), after 5 minutes it will go into sleep mode. In sleep mode, the GSM, Bluetooth and GPS module switch off. Movement, ignition (digital input 1) and external power is still monitored for changes. The tracker also sends a message every hour if no activity is detected.

Sleep mode is canceled - waking up the device - when the internal accelerometer detects movement or when the ignition is switched on.

The device can run at least 48 hours from the internal battery when in sleep mode (waking up every hour) or at least 6 hours when continuously transmitting data.

# Access Control

## General information

The Onyx V4 RFID keypad reader provides driver identification and access control on your existing installation. The waterproof design allows you to install this on both indoor and outdoor machines, independent of the machine model.

The easy connector makes it plug-and-play with your existing Onyx V4 installation. Drivers can authenticate themselves using their personal PIN code or using a mix of RFID technologies such as HID, EM and MIFARE. The built-in LED and buzzer provide immediate feedback to the user, even in a noisy environment. Our GemOne cloud platform allows you to easily manage and assign cards and PIN codes to the different machines, without physical access to the machines.

## Technical specs

Dimensions	122 (L) x 50 (W) x 21 (H) mm
Voltage range	9-18V (Powered via Onyx V4 12V output)
Pin code	1 to 16 digits
Supported cards	HID prox (26-bit, 36-bit, 37-bit, ...) EM ID (26-bit) ISO-14443 MIFARE Classic 1k, DESFire (32-bit and 56-bit)
IP rating	IP67
Temperature	-20°C to 60°C
Weight	180g

## Dimensions



122(L) x 50(W) x 21(H)mm

## Wiring and pinout

The RFID keypad reader comes by default with a connector, plug-and-play with the Onyx V4. The small connector size allows you to easily guide the wiring through your machine to mount the keypad in a convenient location, easily reachable for the operator.

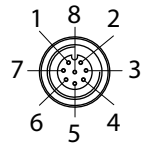

M12 connector

Pin	Name	Description
1	Wiegand D0	Wiegand data lines (D0 and D1) used to send the RFID card number or entered PIN code from the reader to the telematics unit
2	Wiegand D1	
3	LED	Signal from the Onyx V4 to the LED indication on the RFID keypad to switch between red and green
4	V+ (9-18V)	Power supply from the Onyx V4 to the RFID keypad. By default, the RFID keypad is only powered when the machine is on (In1 Key / Keyswitch)
5	Ground	
6	Buzzer	Signal from the Onyx V4 to the Buzzer in the RFID keypad
7 - 8	-	Not in use



## Wiring schematics

Connect the RFID keypad to the telematics unit via the circular M12 connector and fasten the connector using the screwfix.



**Don't use any tools to tighten the screws, hand-tight is sufficient to keep the connection in place.**

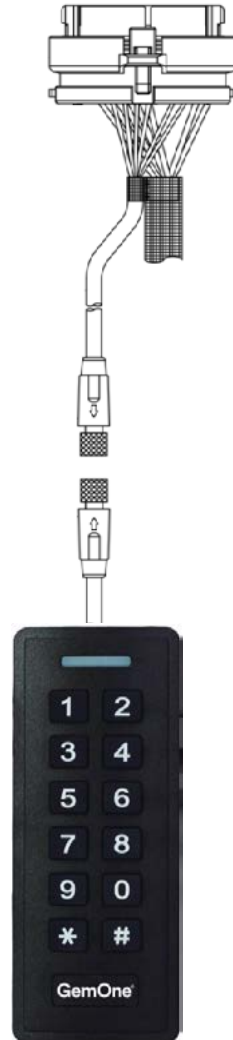

Select a signal in your machine which allows you to block the machine. Place the Relay COM and Relay NO contacts in series with the selected signal. This allows the telematics unit to interrupt the signal to block the machine. See ‘Custom wiring harness and connectors’ on page 15 for more information.

Always make sure that the voltage and current doesn’t exceed the rating of the internal relays! Try to interrupt a signaling wire in the machine instead of a power wire. If you need to interrupt a power signal which exceeds the specs of the internal relay, connect an external relay with the proper rating.

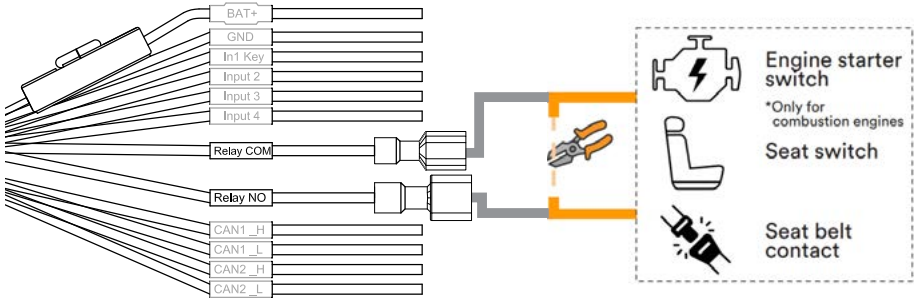

## Which signal to interrupt?

For machines with a combustion engine, the easiest way to block the engine is by interrupting the starter relay. Always make sure the current through the internal ignition blocking relay never exceeds the advertised maximum (2A / 30VDC).

In case of electric forklifts we recommend breaking the ground side of the starter relay coil as the go to option. Alternatives are wiring the ignition blocking relay to one of the following circuits:

- Driver seat switch
- Driver seat belt switch
- Charging switch/input
- ...



**Make sure you never circumvent any of the safety features of your machine; always consult your vehicle's technical manual.**

**It's not recommended to directly interrupt the key switch, always interrupt the coil to the starter engine, driver seat switch, seat belt switch, charging input, ... but in some cases, interrupting the key switch is the only option. If you do, check the voltage and current upfront and make sure you're not exceeding the maximum of the internal relays.**

The relay should never interrupt the key switch signal going to digital input 1. The ignition signal should always be available to the telematics unit, even if the machine is immobilized by the relay.

If the device is installed incorrectly (the key switch signal on digital input 1 drops as soon as the blocking relay activates) then a feedback loop is created, causing the machine to block and unblock in an endless loop:

- Ignition signal is detected on In1 Key
- The blocking relay is activated
- The ignition signal is interrupted on In1 Key because of a wrong installation.
- The blocking relay is deactivated
- The ignition signal is present again since the relay is inactive
- The blocking relay is activated again
- ...

Keep in mind that interrupting the key switch signal on digital input 1 could happen by mistake either directly - by wiring the relay before the digital input, or indirectly - if the machine takes away the ignition signal when the blocking relay is active. Both situations must be prevented.

If your machine has no other option except for interrupting the key switch, then make sure to connect digital input and the relay in the correct order. See next page for a good and a bad example.

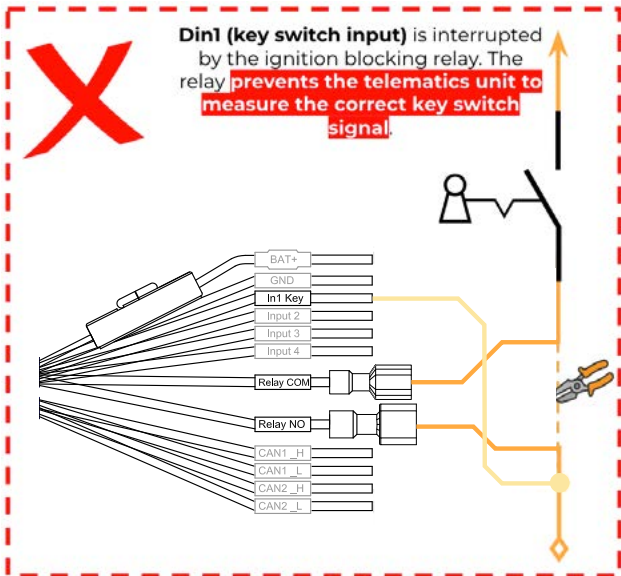
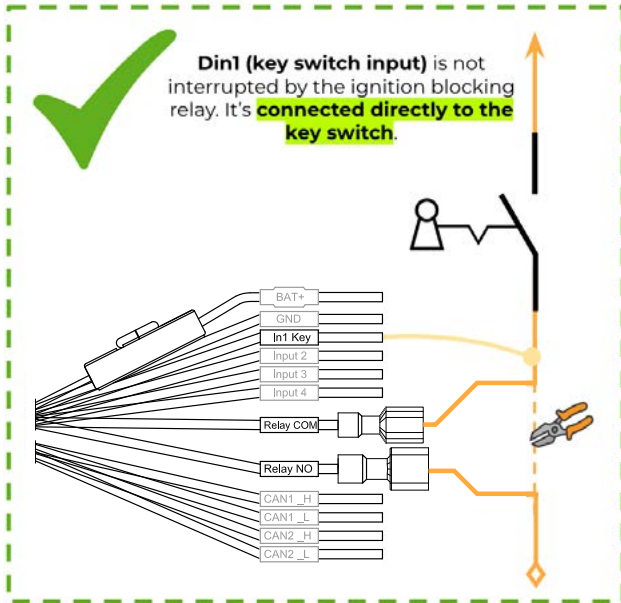

# Telematics connector

Some machines have built-in support for ignition blocking. Models like this have a specific telematics connector or wire that allows the telematics module to block the machine in a safe manner.

We can divide these machines into 2 categories: models with active HIGH or active LOW blocking.

- Machines with active HIGH blocking will disable the ignition when Bat+ is applied to the 'remote machine disable' wire.
- Active LOW blocking on the other hand will disable the ignition when the 'remote machine disable' wire is connected to ground (chassis or Bat-).

Make sure to consult your machine manual for model-specific installation instructions.

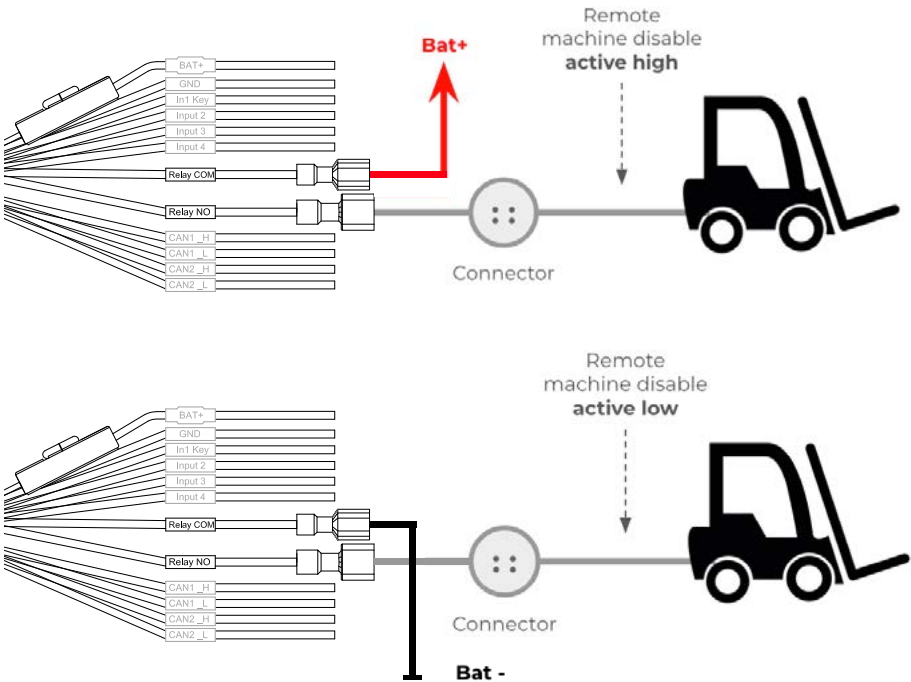

## **How to use**

### **Unblocking a machine**

When a machine is equipped with access control, a driver should use the following steps to unlock the machine:

1. Turn on the ignition using the key switch or on/off switch of the machine.
2. The tracker will now actively block the machine. This is indicated by the red LED on the keypad.
3. To unlock the machine using a PIN code, enter the correct PIN code and confirm by pressing the # sign.
4. To unlock the machine using an RFID card, hold the card on top of the buttons of the keypad. The keypad will provide a short beep when the card is detected.
5. If the PIN code or card was accepted by the tracker, the LED will turn green and the keypad will beep for 5 seconds. The machine is now unblocked and can be operated.

### **Blocking a machine**

1. To end your session on the machine, turn off the ignition using the key switch or on/off switch. A session ends by default 10 seconds after switching off the keyswitch, depending on your settings. The LED stays green or the keypad turns off completely when the session ends, depending on the power settings.
2. To operate the machine again, the unblocking procedure needs to be used as described above.

# Post installation verification

## QR-code on the Onyx V4 device

The housing label on the Onyx V4 contains a QR-code meant for verifying whether the installation has been successful. When scanning the QR-code, the URL directs to an installation verification web page. On this page, a specific set of most recent device parameters can be consulted:



### **Installation verification page**

- GPS location (longitude, latitude)
- Digital inputs (state)
- Analog inputs (state)
- Asset battery voltage (value)
- Device battery voltage (value)
- CAN1 connectivity (yes / no)
- CAN2 connectivity (yes / no)



## **Consulting the installation verification page**

The page is view only and no authentication is necessary to consult the installation verification web page. If the device needs a change in configuration (e.g. change digital inputs, link the device to an asset on the gemOne Cloud, unclaim it on the GemOne Cloud, or any other action) a login button to the GemOne Cloud is available.

## **Keeping machine data secured**

The Onyx V4 features a robust tamper-proof measure to safeguard and prevent access to information from other machines. Thanks to stringent security measures, randomly modifying the URL will lead to an unavailable web page, ensuring that no machine data can be consulted under any circumstances. This advanced protection provides a secure and reliable installation verification experience.

# FAQ / Troubleshooting

## **None of the LEDs turn on**

- Verify if the tracker has power between Bat + (red) and GND (black). The tracker needs a voltage between 9 - 97V to function properly
- Verify if the 1A fuse is still intact if applicable

## **The tracker sends data but I can't see the location of the vehicle.**

Verify if the installation was done according to the guidelines. The QR code should face the open sky, without metal obstructions. See 'Antennas' section for more information.

The GPS signal isn't always available inside so location tracking may not work indoors.

## **Ignition or hour counter input stays high - even if the machine is not running.**

Check if the ignition is actually used by the operators. In a lot of cases, the emergency switch is used instead of the ignition switch. On some machines, this disables the machine but keeps the ignition signal high. The installation must match the actual usage of the machine. If the emergency switch is used instead of the ignition switch, then it might be better to use another point in the machine. Please consult your machine's technical documentation for more information.

The same applies to all other inputs including digital input 2 (hour counter).

## **My machine has multiple control panels - which ignition signal do I use?**

Some machines have multiple control panels, each with its own key switch and/or emergency stops (eg. one on the platform and another on the ground control panel). In that case, you have to make sure that the ignition digital input of our tracker measures both signals. Some machines have a combined signal available, please consult your schematic and manual.

## **I don't get any CAN data in the web portal**

Make sure you've configured the right make and model and enabled CAN in the web portal for this machine. This configuration is used by the telematics unit to read out data via the CAN according to the machines specifications.

Verify if CAN high and low are properly connected, if possible with a twisted pair. Make sure you connect the primary and secondary CAN bus to the right points in the machine. A CAN bus must measure  $60\Omega$  or  $120\Omega$  between CAN High and low. Please check your installation or machine if this is not the case.

Is your machine already supported? If not, check with your sales representative. Machine support can be added after installation via an over the air firmware upgrade.

## **I installed access control but my machine is not blocking**

- **Is the tracker powered correctly?**

In order for the tracker to function correctly, it needs to be connected to a permanent power supply.

- **Is the ignition signal wired correctly?**

Make sure the ignition is connected and turned on. Turning on the ignition is vital, as the tracker will only start blocking the machine once the ignition signal is detected. In1 Key/ACC of the tracker needs a positive voltage in order to block the machine.

- **Is access control enabled on the GemOne cloud platform?**

In order for access control to be enabled on the tracker, cards or PIN codes need to be assigned to the corresponding machine on the GemOne cloud platform. If no cards or no PIN codes are assigned to the machine, access control is disabled on the tracker.

## **The LED of the keypad is off, pressing keys or presenting a card does nothing.**

- **Is the keypad properly connected to the telematics unit?**

Make sure the M12 connector is connected properly to the wiring harness of the Onyx V4 and screwed snug. Check if the contacts are clean and make sure no dirt has entered the connection. Verify if the cable to the RFID keypad is intact and has no kinks or cuts.

- **Is the ignition switched on?**

The Onyx V4 is configured by default to power down the keypad if the machine is not in use (Digital input 1 / keyswitch off).

Make sure the machine is on and check the signal on Digital input 1

## **My machine is blocked, but cannot be unblocked.**

- **Is the keypad properly connected to the telematics unit?**  
Make sure the M12 connector is connected properly to the wiring harness of the Onyx V4 and screwed snug. Check if the contacts are clean and make sure no dirt has entered the connection. Verify if the cable to the RFID keypad is intact and has no kinks or cuts.
- **Is the correct card type used?**  
If the reader doesn't give a short beep while presenting your card, the card is not supported. See 'Technical specs' to get a list of supported cards.
- **Is the RFID card presented correctly?**  
Make sure to hold the RFID card in front of the keypad buttons. Keep the card there for a moment until you get the short feedback beep
- **Is the used PIN or card allowed access?**  
Cards or PIN codes need to be assigned to the corresponding machine on the GemOne cloud platform before they can unlock the machine.

## **My machine keeps blocking and unblocking as soon as I turn on the key switch.**

- **Are the relay contacts and In1 Key connected properly?**  
Make sure the blocking relay is not interrupting the ignition signal on digital input 1. The tracker should always see an active ignition signal, even if the machine is immobilized. See 'Which signal to interrupt' for more information.

# Support

In case of issues, questions or feedback, feel free to contact our support team.

## EMEA

☎ +32 56 93 01 08

✉ [support\\_emea@gemone.com](mailto:support_emea@gemone.com)

## US

☎ +1-844-275-2801

✉ [techservice@gemone.com](mailto:techservice@gemone.com)

## Save time with our connectors

Request for connectors for your machines to save time while installing this tracker. GemOne offers a multitude of different connectors. Get in contact with your account manager for an offer.



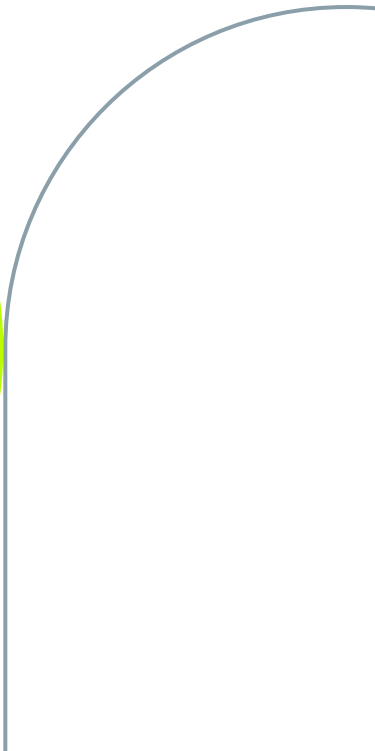
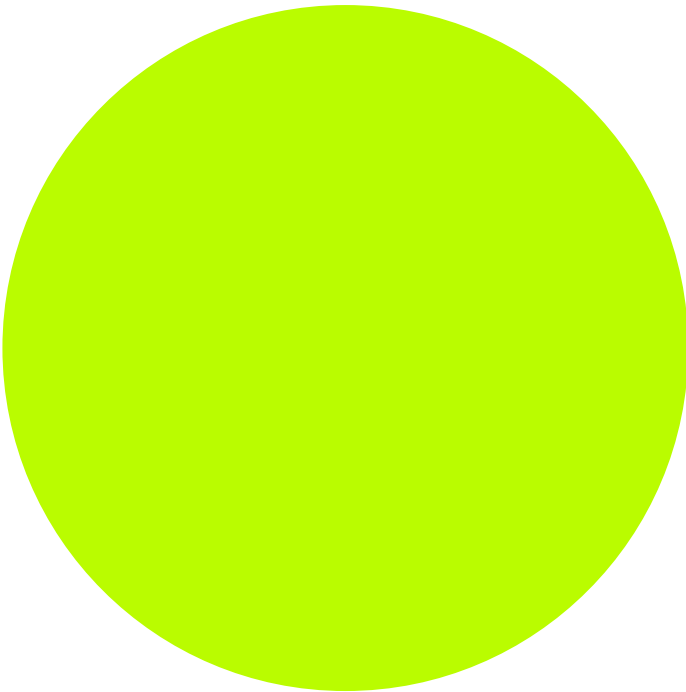

## Lets get connected:

- 📷 [instagram.com/gemoneofficial](https://www.instagram.com/gemoneofficial)
- 📘 [facebook.com/gemone.telematics](https://www.facebook.com/gemone.telematics)
- 🌐 [linkedin.com/company/gemone](https://www.linkedin.com/company/gemone)
- 🐦 [x.com/GemOne\\_](https://x.com/GemOne_)
- 📺 [youtube.com/@gemone7046](https://www.youtube.com/@gemone7046)

[www.gemone.com](http://www.gemone.com)



A company of **TVH** 

©2025 - GemOne NV, Vichtseweg 129, BE-8790 Waregem. All rights reserved. No part of this publication may be reproduced or communicated in any form or by any means, electronic or mechanical, including copying, recording or use in an information storage or retrieval system, without prior and explicit permission of GemOne NV. Photographs and illustrations are included for reference purposes only. GemOne is are registered brand.