

EN

BATTERY MONITORING SOLUTION installation guide

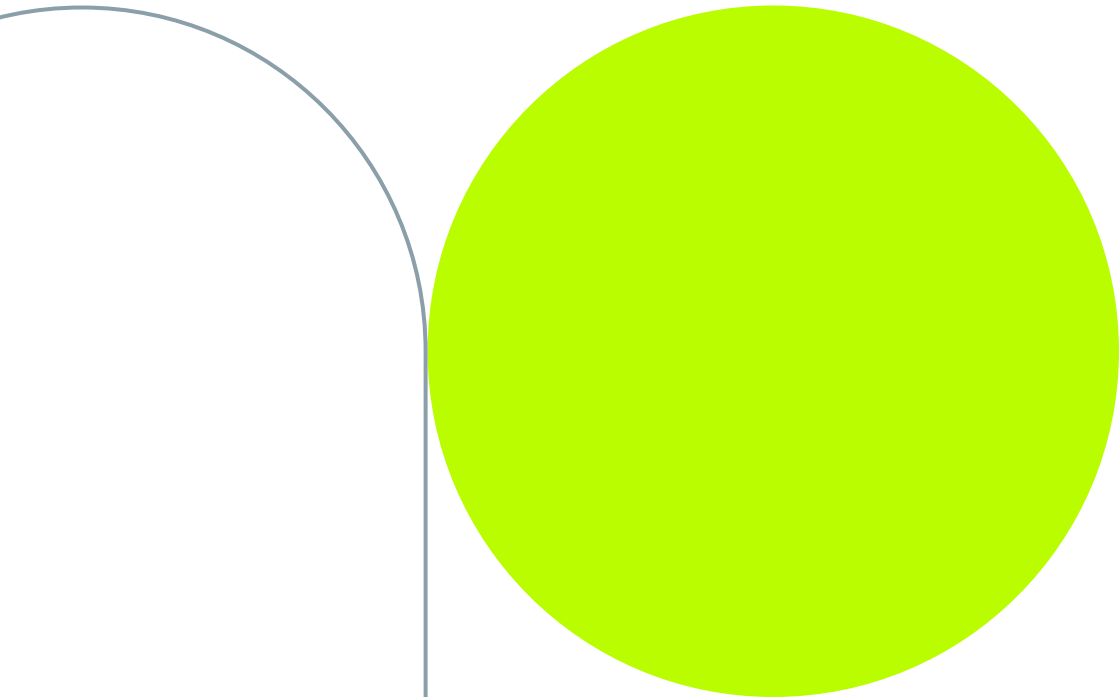



Content

General information	4
Technical specs	5
Dimensions	6
Important instructions	7
Safety instructions	7
Attention	9
Before Installation	9
Connections	10
LEDs	12
Installation	14
Installation block type battery with half voltage	16
Installation cell type battery with half voltage	17
Installation position	18
Support	19

General information

Industrial batteries can be expensive and difficult to manage. The increased electrification of heavy equipment means that consistent battery management has become more important than ever.

Our battery monitoring solution helps you avoid the unnecessary wear of your batteries, prevent the downtime of your battery powered machines, and maximize your battery charge cycles.

Our solution works with machines that use both lead acid and lithium ion batteries across a wide range of voltages to keep you up to the minute on a wide range of operational parameters.



Technical specs

Power

Low voltage - 9-95V absolute min/max, Typically for 24V-60V batteries

High voltage - 40-150V absolute min/max, Typically for 60V-96V batteries

Physical specifications

Dimensions:	1.22 × 1.57 × 7.32 in.
Weight:	0.88lbs
Ingress protection:	IP68
Operating temperature:	-4°F to 158°C
Conformity & Certifications:	CE/RED, ...

Consumption:

Maximum: 3W

Normal operation: 0.5 - 2W

Sleep mode: <0.3W

Hardware protection (low voltage):
0W

Sensors

Temperature:
-4°F to 230°F (33.8°F resolution)

Electrolyte level

Digital inputs: 2

Current - using Hall sensor
(0.1A resolution)

Low voltage: 300A

High voltage: 800A

Voltage (0.01V resolution)

Low voltage: 9 - 95V

High voltage: 40 - 150V

Connectivity

2 status LEDs

Hardware support for CAN2.0A/B
(reserved for future use)

Bluetooth Low Energy 4.2 and 5.0

Global coverage using 4G LTE Cat 4
with 2G/3G fallback using

3 hardware versions:

EUX Europe, Middle East, Africa,
Thailand and Singapore

AUX Australia, New Zealand,
Latin America, Japan
and South Korea

AFX North America

GNSS (positioning)

GPS

GLONASS

BeiDou

Dimensions

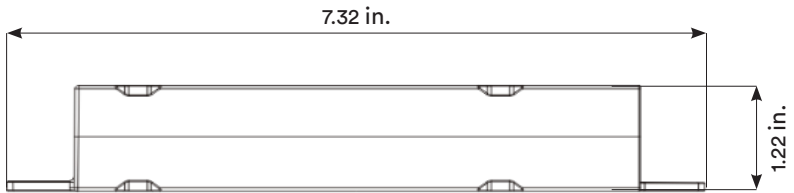
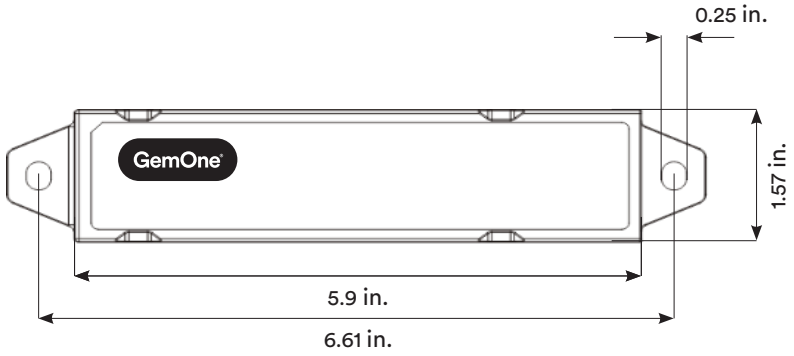

Important instructions

When installing and operating this unit, the following instructions in the installation manual must be followed exactly and the use of the unit within its technical specifications (see installation manual) must be strictly observed.

Failure to do so may result in damage to the unit and possible personal injury and/or property damage. Failure to observe the installation instructions or operation of the unit outside its technical specifications will result in the loss of any claims for compensation against the supplier or manufacturer of this unit.

Safety instructions

In order to make a warranty claim, proof must be provided that the product complained about has been installed in accordance with the installation instructions, including the accessories and tools mentioned, and that it has been operated within the scope of the specification. We reserve the right to inspect the product complained about. Any liability for consequential damage attributed to a defective product is excluded and not subject to this warranty provision.

The unit is designed for installation on lead-acid batteries (wet or VRLA) used in sealed enclosures. **Avoid prolonged exposure to acidic liquids.**

The user must ensure that these enclosures are closed during operation and protected from unauthorised access.

For use on other battery technologies (NiCad, Lithium. etc.), the installation and safety instructions of the respective battery manufacturers must be observed.

Lead-acid batteries contain highly reactive and aggressive components and should therefore be handled with the utmost care. Use protective goggles and clothing during installation of the unit.

Only by installing and operating the unit as intended, can the intended operation of the unit be guaranteed and injury to persons and damage to the unit and / or property be avoided. The operating personnel must be authorised and qualified to work with the unit. Ensure that all operational staff have the necessary personal protective equipment.

When installing the unit, be sure to follow the instructions shown. The unit is protected against polarity reversal. If the polarity is reversed or the connection is faulty, check the built-in fuses. The unit must then be connected with the correct polarity and correctly.

The unit must be handled with care. Protect moving cables and plugs from being pinched or damaged in any way. When installing the supply and measuring lines, make sure that they do not cross and are not in direct contact with heat-generating parts (e.g. battery terminal). Make sure that the unit's cables are properly fixed to the cell connectors using cable ties.

Pulling on moving cables can loosen or disconnect the electrical connections. Damaged units, even if they still function, must not be used further (danger to persons/property). Any mechanical damage to the unit must be repaired immediately by qualified personnel. An externally damaged unit must not be installed. If the unit should fall down or otherwise be exposed to external force before or during installation, we do not assume any warranty for proper function and operational safety. In this case, the unit must be returned to the seller for inspection.

When installing the unit, **it is essential to observe the rated voltage indicated** on the unit. Connecting to a different nominal voltage (higher or lower than specified) may result in incorrect measured values. If the units are connected above the maximum permissible value of the operating voltage, the unit may be damaged. If the unit is connected below the minimum permissible operating voltage, the unit will not operate as intended. In particular, data loss may occur.

The unit will only function properly in the specified temperature range, altitude range and humidity. To avoid damage, the plastic materials used in particular must not be exposed to influences outside the specification. If the unit is operated outside the specification, proper function is not guaranteed.

The housing of the unit is designed for operation on lead-acid batteries and can therefore be used in acidic environments. Nevertheless, it must be ensured that the battery is regularly cleaned of acid residues in order to avoid permanent contact of the unit with the acid.

Attention:

If the unit and the cable connections are permanently exposed to acidic liquid, damage may occur in and/or on the unit and cabling. When cleaning, the relevant safety instructions must be observed.

Before Installation:

Make sure the rated nominal battery voltage is suitable for the BMS version (low or high voltage).

Make sure the max. charge or discharge current fits in the range of the hall sensor (max. 300 or 800A)

Connections

You can find the wiring scheme of the basic installation below.

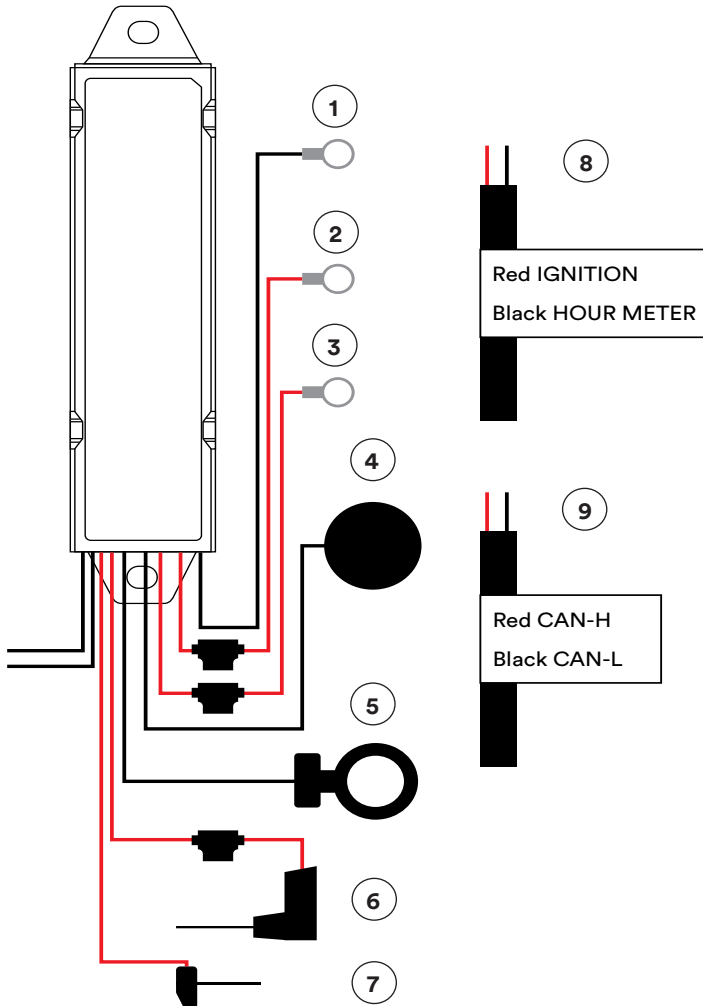

NR.	FUNCTION	SPECIFICATION
1	Negative terminal	Main supply negative terminal. M10 connector, attach to the ‘-’ pole of your battery (mandatory)
2	Positive terminal	Main battery voltage input - also the supply voltage of the BMS system. M10 connector, must be connected to the positive terminal of the battery. Protected with 2A fuse. (mandatory) Low voltage - 9-95V absolute min/ max, Typically for 24V-60V batteries High voltage - 40-150V absolute min/ max, Typically for 60V-96V batteries
3	Half voltage	Half voltage input used to detect cell imbalance. If used, this should be connected to exactly half the battery voltage. Protected with 2A fuse. (optional)
4	External antenna	External antenna, used for data transfer and positioning (mandatory) Data: GSM + 4G antenna GNSS: GPS + GLONASS + BeiDou
5	Current sensor (hall)	Hall sensor used to measure charge and discharge currents (mandatory) Low voltage - 300A High voltage - 800A
6	Level sensor	Electrolyte contact probe with 2A fuse (optional but recommended)
7	Temperature sensor	Temperature probe to install between batteries (optional but recommended) Please keep in mind that the temperature sensor is an external probe and cannot be installed inside the cell.
8	Digital inputs	Digital inputs to measure ignition contact (key switch) and/or operating hours of the machine. (optional)
9	CAN interface	Reserved for future use (do not connect)

LEDs

Status LED inside the body

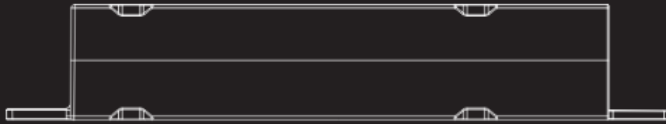

Status LED

RED	GREEN	STATUS
On	Off	Power up
Off	Flash	Network connected
Flash	Flash	Firmware updating



GemOne

www.gemone.com

GPBM



Designed & Manufactured by GEM

Installation

Connect power supply (1), (2), (3)

- Connect the **Main-Input (+)** cable (2) with a fuse to most positive terminal.
- Connect the **Main-Input (-)** cable (1) to most negative terminal .
- Connect **AUX-Input (+)** cable (3) to positive terminal of half voltage.

Install Level Sensor (6)

- Cut the Level sensor such it is 0.11 in. above the electrode plates.
- Strip the heat shrink of the level sensor by approx. 5mm.
- Install minimum in the 3rd cell, counting from negative pole or 6V battery.

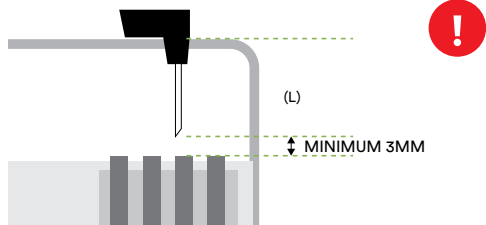
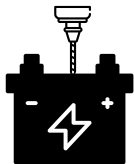
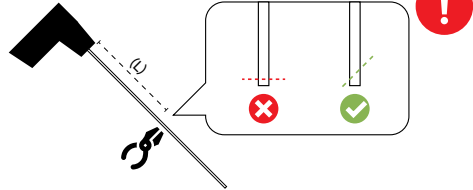
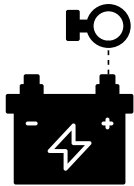

Install hall sensor (5)

The Current Sensor **must** be placed **ONLY** around the main battery cable of the most negative or positive battery pole. An installation around the inner cell connectors can produce wrong measurements. Tighten the Current Sensor with a **cable tie** to the main battery cable, so it can not move.

- Open the hall sensor and put the charging and loading cable through it.
- Close the hall sensor
- Make sure the arrow is pointing towards the positive terminal.
- Adjust the hall sensor with a cable tie to the cable, so it can not move.



Temperature sensor (7)

Install the temperature sensor between cells/ batteries in the center of the battery pack. Please keep in mind that the temperature sensor is an external probe and cannot be installed inside the cell.

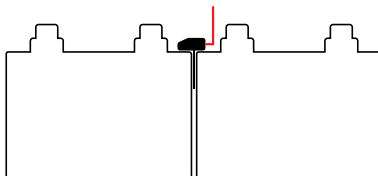

Fuse

2A for Main-Input (+) (1), AUX-Input (+) (2) and Level Sensor (4).

Installation block type battery with half voltage

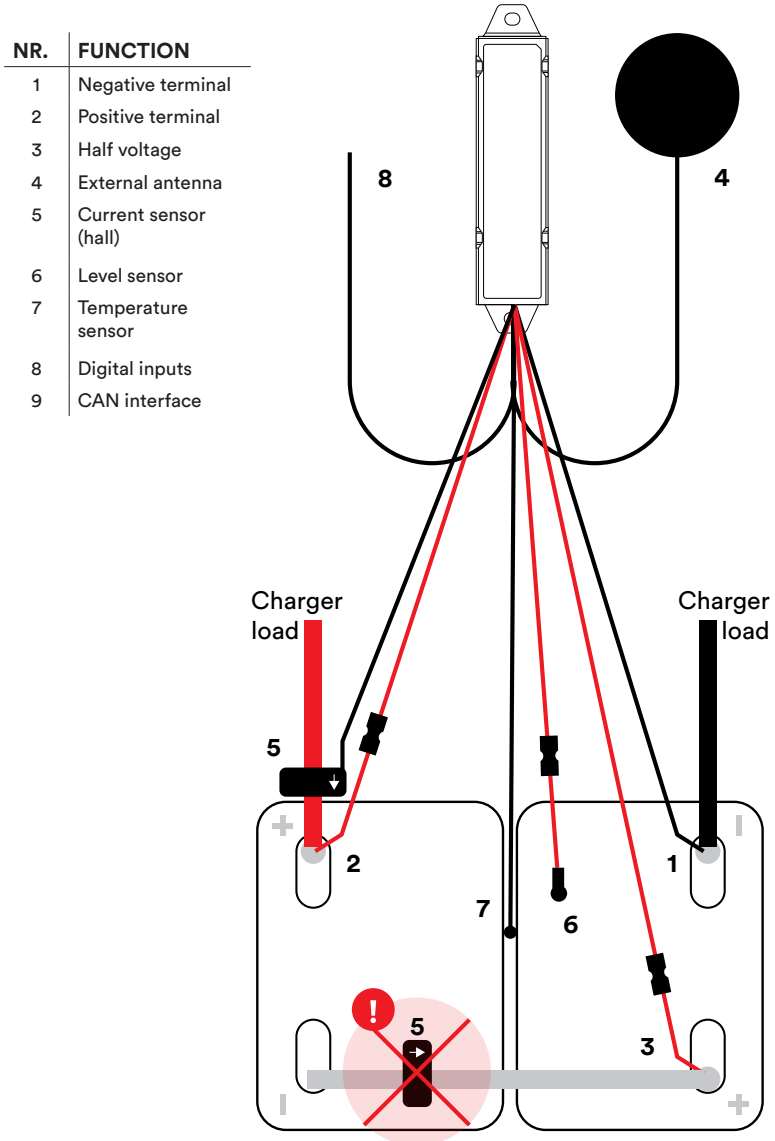

Installation position:

Attach the BMS device to the battery and make sure it doesn't move around during machine operation. Make sure to mount the BMS device with the logo up so serial etc are still visible.

Place the antenna outside of the metal shielding of the battery, facing up towards the sky for best mobile signal and positioning. When your machine has a fixed battery which is charged in the machine itself (no battery swaps) it might be better to mount the antenna on the machine itself - with a clear and unobstructed view towards the sky.

Support

After installation, write down the device serial number with the basic parameters of your battery:

- Battery type (with Brand and/or serial)
- Battery nominal voltage (eg. 24V, 48V, ...)
- Battery capacity in Ah
- Battery C rating (C5, C6 or C20)
- Battery number of cells

Share this with our support team so they can configure your device for accurate measurements.

In case of issues, questions or feedback, feel free to contact our support team.

 +1-844-275-2801

 techservice@gemone.com

Save time with our connectors

Request connectors for your machines to save time while installing this tracker. GemOne offers a multitude of different connectors. Get in contact with your account manager for an offer.



Lets get connected:

- 📷 [instagram.com/gemoneofficial](https://www.instagram.com/gemoneofficial)
- 📘 [facebook.com/gemone.telematics](https://www.facebook.com/gemone.telematics)
- 🌐 [linkedin.com/company/gemone](https://www.linkedin.com/company/gemone)
- 🐦 twitter.com/GemOne_
- ✉️ support_emea@gemone.com

www.gemone.com



©2022 - GemOne NV, Spinnerijstraat 99/23, BE-8500 KORTRIJK. All rights reserved. No part of this publication may be reproduced or communicated in any form or by any means, electronic or mechanical, including copying, recording or use in an information storage or retrieval system, without prior and explicit permission of GemOne NV. Photographs and illustrations are included for reference purposes only. GemOne is a registered brand.